

ECOUSTIC® CEILING FLATS TIMBRE POINT INSTALLATION & CARE



unika vaev

INSTYLE

Hear yourself think®

ECOUSTIC® CEILING FLATS TIMBRE POINT - INSTALLATION

ASSEMBLY INSTRUCTIONS

Supplied

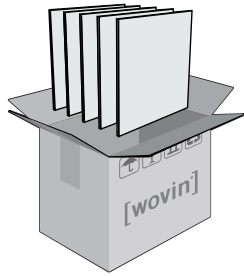

0.35" + 0.47" Thickness
24 x 24 Tiles [16] per box
48 x 24 Tiles [8] per box

0.94" Thickness
24 x 24 Tiles [8] per box
48 x 24 Tiles [4] per box

Sold as a single color per box

Source

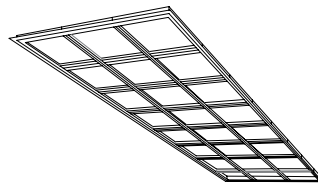

Pre-existing or newly installed drop ceiling T-frame
24" x 24" [centers]
or
48" x 24" [centers]

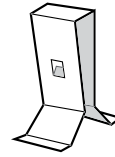

Hold down clip [4] per tile

Suitable for your grid system

Essential

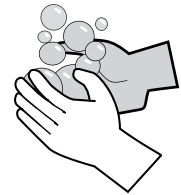

Clean hands and be sure to handle with care during installation process

INSTALLATION

Step 1

Check the pre-existing or newly installed frame in which to suspend the Ceiling Flats Timbre Point.

Ensure the frame has been correctly installed with a suitable sized aperture for the tiles and the frame is square and true.

Step 1

The tiles can be dropped in place from the rear of the frame or slotted through from the visible side.

Take care not to bend the tile. The use of suitable hold down clips are mandatory on Ceiling Flats Timbre Point, [4] per tile.

Step 1

Continue to fill the frame with Ceiling Flats Timbre Point.

Finish the installation in a discreet area as the last tile can remain unclipped to act as access to the plenum.

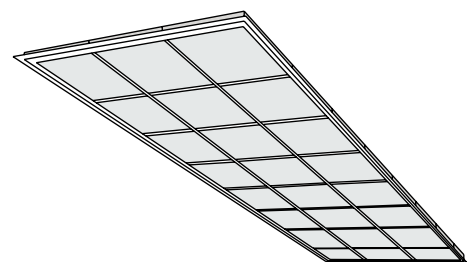
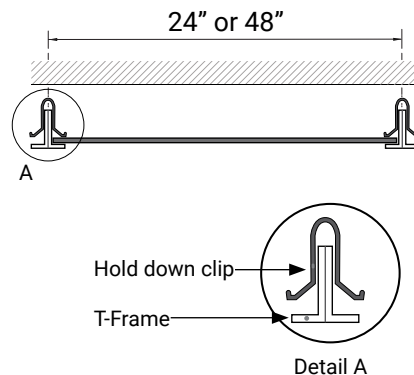
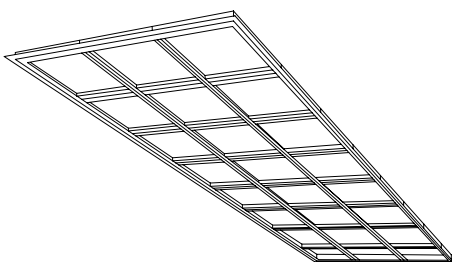

ECOUSTIC® CEILING FLATS TIMBRE POINT - CARE

Please Note

- Care must be taken when cleaning as these instructions apply to the fabric face only and the possible effect of the cleaning regime on underlying bases and ceiling surface must be considered
- For these reasons it is suggested to spot clean only and that it be carried out by a professional cleaner

Regular Care

- Protect from direct heat and sunlight
- To prevent dust build up, lightly dust with a soft cloth or vacuum with a soft brush attachment

Cleaning

- Professional cleaning is always recommended
- Always test any any cleaning products on an inconspicuous area prior to commencing cleaning
- Blot any excess spills from the material with a dry clean sponge or cloth
- Treat all stains and spills as soon as possible
- Most marks can be spot cleaned by lightly wetting the affected area with a mild detergent and warm water solution
- Do not saturate the tile
- Do not scrub or abrade the tile surface as this will affect the surface finish
- Once the stain or mark has been loosened then blot the excess solution out with a dry clean sponge or cloth
- Sponge afterwards with clean warm water and dry any excess moisture with a dry clean sponge or cloth
- The product can also be spot cleaned with dry cleaning fluid, lightly sponge a small amount of dry cleaning fluid and blot
- Dry away from direct heat and
- Do not use carpet shampoo